

Stationary Three-phase Meter Test Bench

Calmet TB41

- Fully automatic procedures for meter testing
- Accuracy class 0.02% or 0.04% with internal reference standard
- Extremely high accuracy class with external reference standard
- Wide range of voltage 20...600V at 150VA and current 0.001...120A at 300VA per phase
- Independent operation of voltage and current signals in each phase
- Harmonics up to 40th and special shapes generation capability
- Simultaneously testing up to 4 meters with different constants
- Testing of single- & three-phase meters with & without closed I-P links
- Small size, light weight and economy powering max. 2000VA at fully possibilities according to EN-IEC 62057-1 standard
- Compact power source with internal reference standard can be applied as three-phase portable test system without need of an external PC

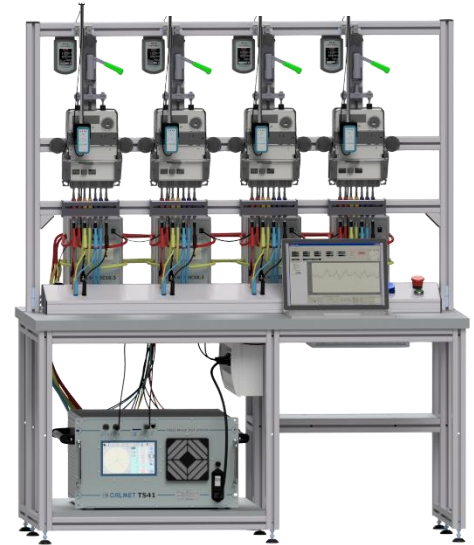

The Calmet TB41 Test Bench is a fully automatic meter test system that used for simultaneously testing and calibration up to four electricity meters. The Calmet TB41 is a modern solution for customers as utilities, meter manufacturers and meter test laboratories.

The Calmet TB41 is designed for testing all types of electricity meters:

- single-phase and three-phase in measurement mode 2W, 4WY, 3WΔ,
- electromechanical and electronic, with and without closed I-P links, prepaid meters,
- active, reactive and apparent energy: P, P+, P-, PH1, PH1+, PH1-, Q, Q+, Q-, QH1, QH1+, QH1-, S, S+, S-, SH1, SH1+, SH1-,

The Calmet TB41 performs the following tests of electricity meters as required by international standards:

- accuracy test (basic error), repeatability, register, meter constant, starting current, no-load run,
- the influence of voltage, frequency, reversed phase sequence, self-heating and harmonic distortion of currents and voltages.

The Calmet TB41 includes the following components:

- three phase power source with integrated internal reference standard,
- four positions suspension rack for meter hanging with quick connection devices, scanning heads, error calculation system with individual error displays and also Isolating Current Transformers ICT,
- PC laptop with Windows TB PC Soft for process control, use of databases as also as visualization, reporting and data export.

The Calmet TB41 Test Bench employs modern precision three-phase power source with the internal reference standard. By this conception may be achieved solution characterised by extremely compact size, light weight and economy powering. In case of higher-accuracy requirement, it is possible by adding an external standard.

Configuration of the Calmet TB41

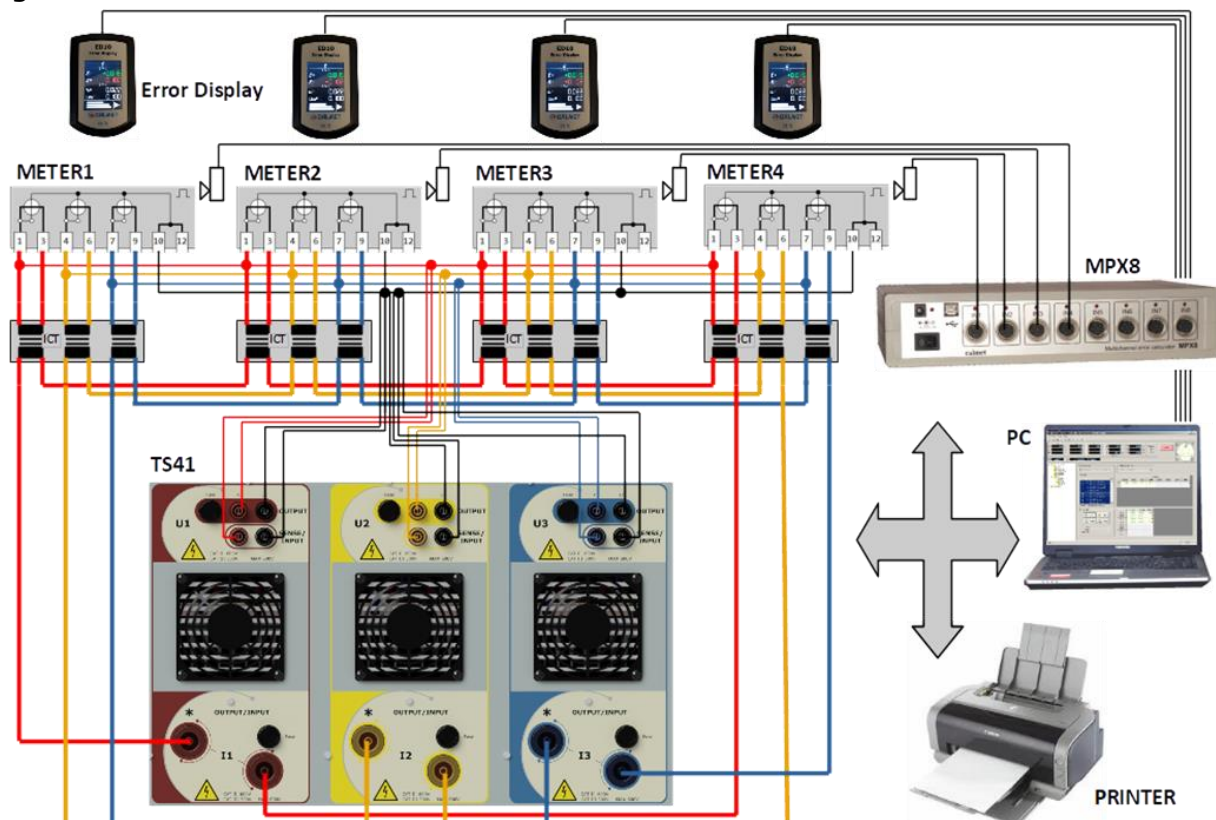

Three Phase Power Source					
Parameter	Range	Settings span	Resolution	Accuracy ¹⁾²⁾³⁾	Maximum load
Voltage U	150V	20...150V	0.001V	See the specification of reference meter	3 x 150 VA
	300V	150...300V	0.01V		3 x 150 VA
	600V	300...600V	0.01V		3 x 150 VA
Voltage stability (T=5s, N=24)				±0.01% / 2min	
Voltage stability (T=150s, N=24)				±0.002% / h	
Voltage distortion factor				< 0.5%	
Current I	0.12A	0.02...0.12A 0.001... <u>0.02</u>	0.00001A	See the specification of reference meter	3 x 0.6 VA
	1A	0.12A...1A	0.00001A		3 x 30 VA
	12A	1...12A	0.0001A		3 x 168 VA
	120A	12...120A	0.001A		3 x 300 VA
Current stability (T=5s, N=24)				±0.03% / 2min ⁴⁾	
Current stability (T=150s, N=24)				±0.005% / h ⁴⁾	
Current distortion factor				< 0.5% ⁴⁾	
Frequency f	45...65Hz		0.001Hz	±0.003Hz	
Phase shift φ	-180°...+180°		0.001°	±0.10°	
Phase angle stability (T=150s, N=24)				±0.005% / h	
Generation of harmonics in voltage and current	amplitude	0...50% output value ⁵⁾	0.1%	±1%	up to 40 th or 2000Hz
	phase angle	-180...+180°	0.1°	±1°	
Generation of special test signals	Phase fired waveform with odd harmonics and Burst fired waveform with subharmonics acc. to the IEC 62057-1, IEC 62052-11 and EN 50470-1,2,3				

- ¹⁾ absolute extended uncertainty under confidence level of 95% covers reference uncertainty of standards, stability in 12 months, influence quantities (ambient temperature +20...+26°C, humidity and power supply voltage 85...265V, frequency 47...63Hz)
²⁾ % - related to the setting value, %* - related to the setting span final value (is underlined)
³⁾ for an averaging time of 180s
⁴⁾ in current range 0.02...120A
⁵⁾ 50% of output value for frequency range of harmonics to 500Hz with linear decrease to 10% of output value for 2000Hz. The peak value of the current or voltage may not exceed 1.4 I_{max} or 1.4 U_{max}

Reference Standard

Parameter	Range	Accuracy ¹⁾²⁾³⁾		
		class 0.02	class 0.04	
Voltage	10...600V	±0.02%	±0.04%	
Current	0.01...120A 0.001... <u>0.01A</u>	±0.02% ±0.02%*	±0.04% ±0.04%*	
Power and energy	0.01...120A / 10...600V 0.001... <u>0.01A</u> / 10...600V	±0.02% ±0.02%*	±0.04% ±0.04%*	
Frequency	40...70Hz	±0.01Hz		
Phase angle	-180...+180°	±0.01° ⁴⁾	±0.02° ⁴⁾	
Power factor cosφ and sinφ	0...±1	±0.001 ⁴⁾		
Voltage and current - temperature coefficient		0.001% per 1°C in range -10...+50°C		
Power short term [1h] stability		±0.005%	±0.010%	
Power long term [1 year] stability		±0.010%	±0.025%	
Power temperature coefficient per 1°C		±0.001%	±0.002%	
Harmonics in voltages, currents, P and Q powers	amplitude	0...100% of input	1 st ...63 rd	±0.1% ⁵⁾
	phase	-180...+180°		±0.5° ⁶⁾
Total harmonic distortion THD in voltages and currents		0...100% of input	1 st ...63 rd	±0.1% ⁵⁾
Total interharmonic distortion TID in voltages and currents		0...15% of input	40...3200Hz	±0.2% ⁷⁾

Specifications for impulse input/output

Parameter	Voltage range	Frequency range	Resolution	Accuracy
Impulse Input for counting pulses (two inputs)	0...2V/4...30V	0.0001Hz...210kHz	0.0001%	0.001% @ t ≥ 1s
Impulse Output for Calmet TS41 testing	Open collector 28V/100mA	0.0001Hz...210kHz	0.0001%	0.001%

- ¹⁾ % - related to the measuring value, %* - related to the measuring range final value (is underlined)
²⁾ absolute extended uncertainty under confidence level of 95% covers reference uncertainty of standards, stability in 12 months, influence quantities (ambient temperature +20...+26°C, humidity and power supply voltage 85...265V, frequency 47...63Hz)
³⁾ power and energy errors related to apparent power
⁴⁾ in current range 0.01...120A
⁵⁾ of input for 80-140Hz frequency range of harmonics with linear rise to 0.4% of input for 3200Hz
⁶⁾ for 80-140Hz frequency range of harmonics with linear rise to 8° for 3200Hz
⁷⁾ of input for 80-140Hz frequency range of interharmonics with linear rise to 5% of input for 3200Hz

General parameters

Mains supply voltage	85...265 V , 47...63 Hz
Power consumption	max. 2000 VA
Safety: Isolation protection and Measurement Category	IEC 61010-1 and 300V CAT III
Degree of protection	IP-20
Operation / storage temperature	-10...+40°C / -20...+60°C
Operation / storage relative humidity	<90% @ +0...+30°C and <75% @ +30...+50°C / <95% @ 0...+50°C
Dimensions: width x height x depth	(128 x 156,5 (159,5) x 70)cm
Weight without ICT / with ICT	140kg / 188kg

The Calmet TB41 Test Bench is controlled by means of personal computer with installed TB PC Soft in MS Windows operating system.

TB PC Soft features:

- using a modern concept, which allows the operator to create own test procedures - this is very important because new requirements for new meter generations can be realized easily without changing the complete software,
- the automated mode - direct execution of the complete test procedure automatically and requires no more additional handling by operator unless it will not be defined in the test procedure,
- the manual mode - direct execution of single test step. It offers an ideal solution for tests and evaluation of entire specifications for devices under test without generating the complete test procedure,
- computer database of customers, devices, measurement procedures as well as edition of results, diagrams, tables of results and reports,
- export of results to MS Excel.

Advantages of TB PC Soft:

- user-friendly operation,
- demonstration software allows training to be given before delivery of the test system,
- operator interface available in several languages,
- fully-automatic and manual modes of testing,
- continuous monitoring of the test,
- all basic data (customers, devices, procedures, results) are integrated in the software libraries,
- flexible access (export/import) to database,
- fast creation of new procedures,
- tables and graphics for presentation of results,
- automatic creation of test report.

Meter type window for entering data to tested devices database, contains the electrical and functional definitions of the **Device Under Test – DUT** (base voltage and current values, maximal current value, accuracy class of the DUT, meter constant, meter connection,...).

Procedure window for entering data to measuring procedures database, describes the order and content of the various test steps in a sequence. For each test step are specified following data:

- parameters of test point (point name, percentage value of the base voltage and current, phase angle or power factor, frequency, waveform of the voltages and currents,...),
- test type (error test, counting test, counter test),
- test method (impulses counting or time counting for error test) and percentage error limit of the DUT,
- test duration for calculating of the standard deviation of error (number of cycles, time of the test point, energy dosage to counting).

Configuration window describes configuration of the MPX8 Multiplexer inputs (active / not active) and description of connected DUT (name, serial number and other necessary information).

Additionally the configuration window allows to set the external reference meter (option) connected to the 8th of the MPX8 input.

Autotest window for performing test of the DUT (tests of accuracy at reference conditions, repeatability, meter constant, starting and no-load condition, effect of influence quantities and tests of effect of disturbances of long duration as reversed phase sequence, voltage unbalance, self-heating, odd harmonics, even harmonics, subharmonics,...) according to measuring procedure in the manual mode or in the automated mode. The autotest function allows to allocate to a measurement procedure a meter type and select a test sequence.

During the test, the operator will be informed about:

- point status (passed / not passed, active point),
- progress indicator (cycle, point and procedure),
- error values for all DUTs in consecutive cycles,
- values of average error, standard deviation and error limit for all DUTs.

Additionally, in any time, the operator can pause or stop a procedure and repeat selected point.

Table result window makes possible visualization and edition measured results in form of table and consists of measured results

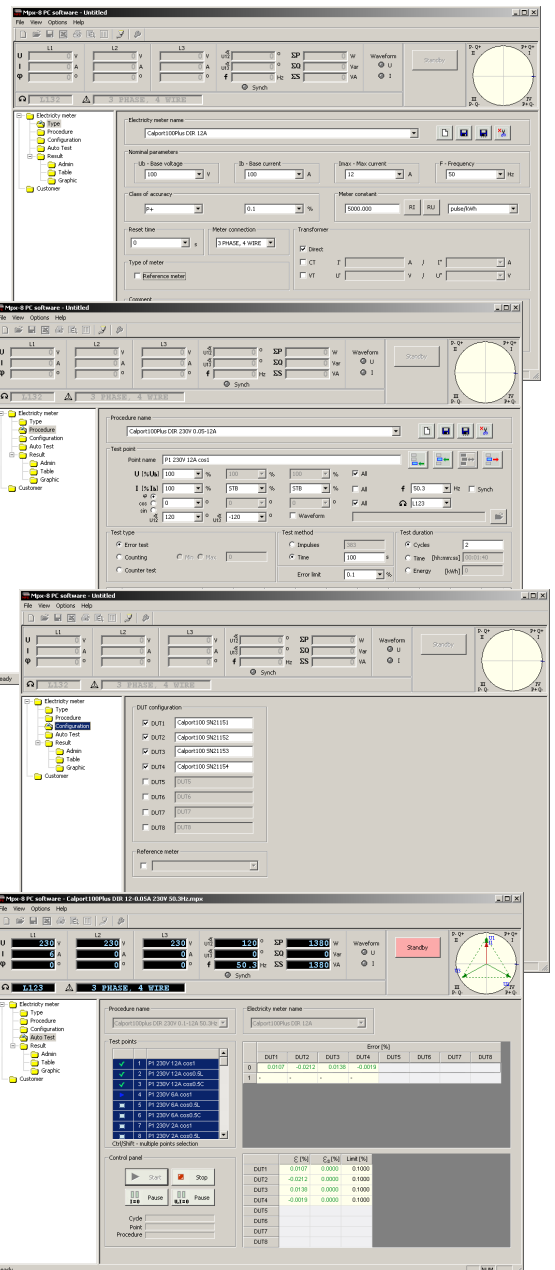

of DUTs in two kinds of table: table of individual DUTs results and table of all DUTs results.

During an automatic test sequence it is possible to view test results and after executing an automatic test sequence all saved results are available for further data processing (printing and exporting data to MS Excel).

Graphic result window makes possible visualization of measured results in form of diagram of error function with error limits.

The graphic result is fully customizable. The operator can change:

- add or hide graph of selected DUT to diagram,
- color of any graph,
- quantity of X axis (no, time, current, voltage,...),
- zoom in and out of diagram.

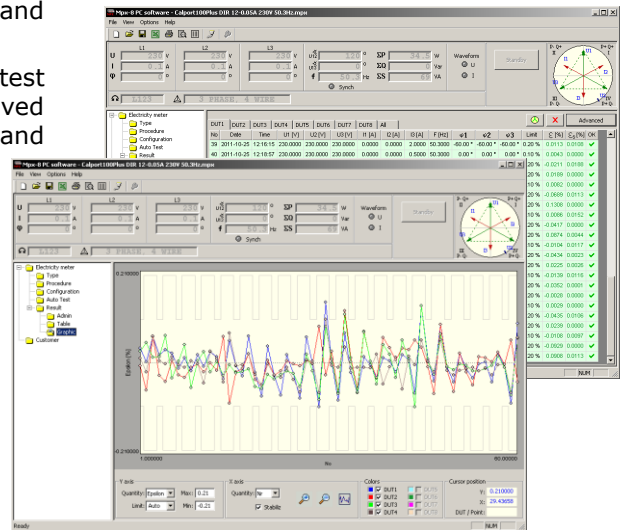

The Calmet TB41 Meter Test Bench's set



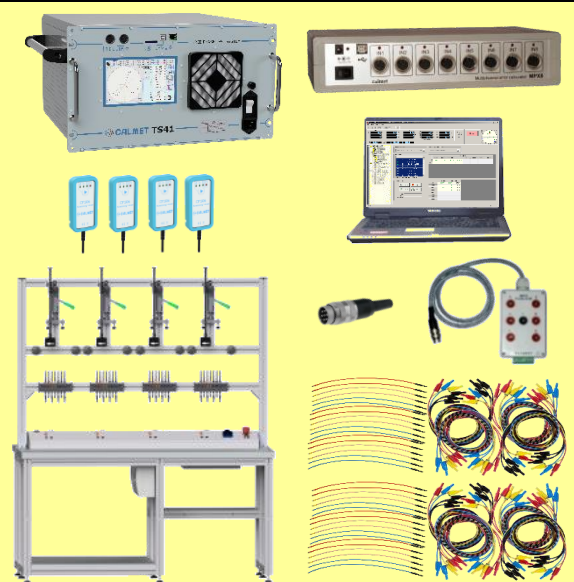

Calmet TB41

All completed Calmet TB41 Test Bench's set consists of:

- TS41 automatic test system class 0.02 or 0.04,
- MPX8 Eight Inputs Meter Error Calculator with TB PC Soft (for controlling the process of simultaneously testing up to 4 energy meters),
- ER41H.3 four position testing stand including:
 - ER41 4-positions test rack for hanging 3-phase meters,
 - EH10.3 quick connection device (4units),
 - EA39 set of safety voltage cables 0,4m(16units),
 - EA40 set of safety voltage cables 0,5m (12units)
 - EA37 set of current cables up to 120A (15units) for working without ICT**),
- Computer Laptop PC with PC software,
- CF106 photo head for inductive meter and meter with LED (4units),
- AD300 sockets adapter,
- flexible Cu wires (12units),
- power cord (2units),
- fuse T4A, 250V, 5x20 (2units),
- C091A T3475-001 plug Amphenol for Calibrator inputs,
- operation manuals and assembly manual,
- warranty card and manufacturer calibration certificate.

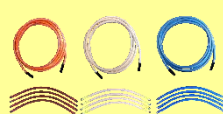

Optionally for Calmet TB41 Test Bench are available:

<ul style="list-style-type: none"> • EC10.3 ICT current isolation transformer up to 120A (4 units) 		<ul style="list-style-type: none"> • ED10 individual error display (4 units) with cables 	
<ul style="list-style-type: none"> • EA38 set of current cables up to 120A (15 units) for working with ICT 			
<ul style="list-style-type: none"> • External high accuracy reference meter Radian Research 		<ul style="list-style-type: none"> • C091A T3475-001 plug Amphenol for TS41 system inputs 	

*) All images are for illustrative purposes only and are subject to change

**) In case of choosing the option with EC10.3 ICT current isolation transformer, the EA37 current cables are replaced with EA38 cables

Calmet sp. z o.o.
 Kukulcza 18, 65-472 Zielona Gora, Poland
 Phone +48 68 324 04 56 Fax +48 68 324 04 57
 E-mail: mail@calmet.com.pl Web access: <http://www.calmet.com.pl>